

1: 200

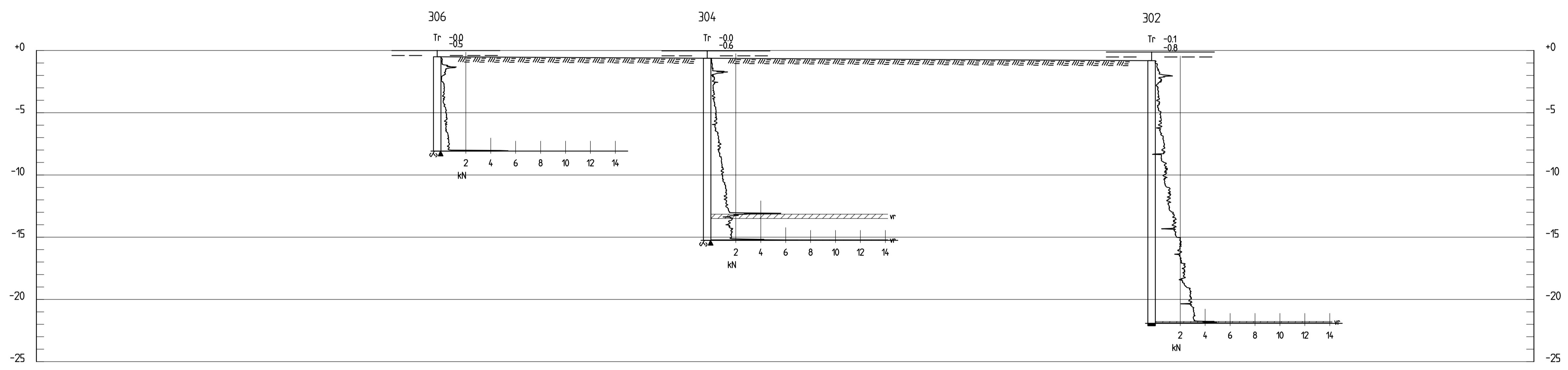

SEKTION A-A  
 1: 200

BET	ANT	ÄNDRINGEN AVSER	SIGN	DATUM
-----	-----	-----------------	------	-------

**ARÖD**  
 RÖNNÄNG, TJÖRNS KOMMUN  
 DETALJPLAN



UPPRAGSNR 17023	RITAD K DRWAL WARTA
DATUM 2017-07-10	HANLÄGGARE H LUNDSTRÖM
GRANSKAD DL	UPPRAGSANSVARIG HENRIK LUNDSTRÖM

**GEOTEKNISK UNDERSÖKNING**  
 SEKTIONER 301 OCH A-A

SKALA (FÖRHÅT)	(A1)	RITNINGSNR	BET
1:200		G301	

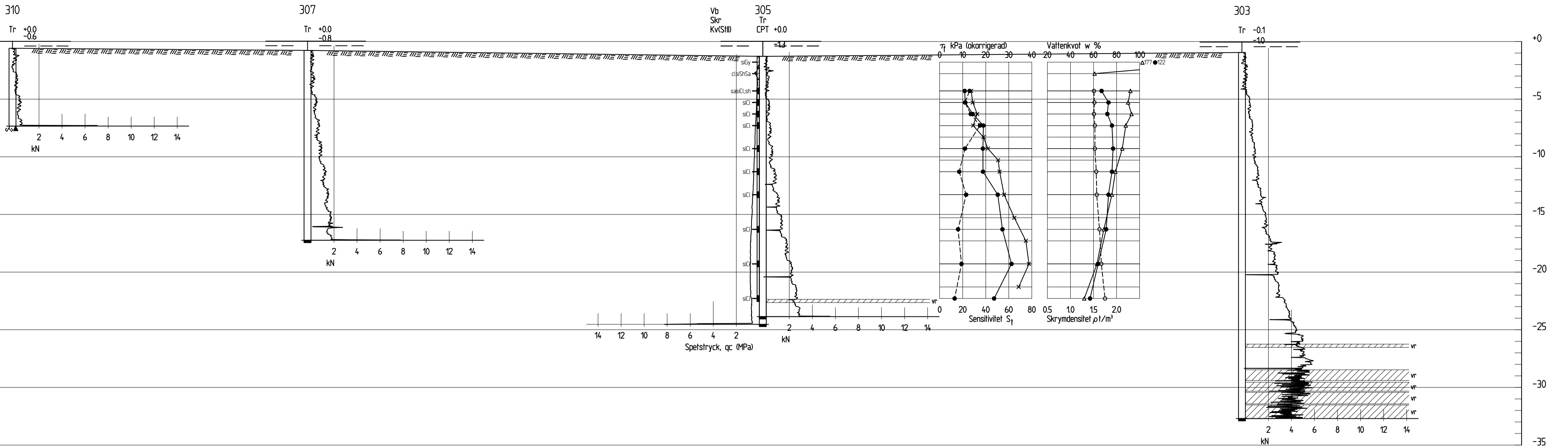

SEKTION B-B  
1: 200

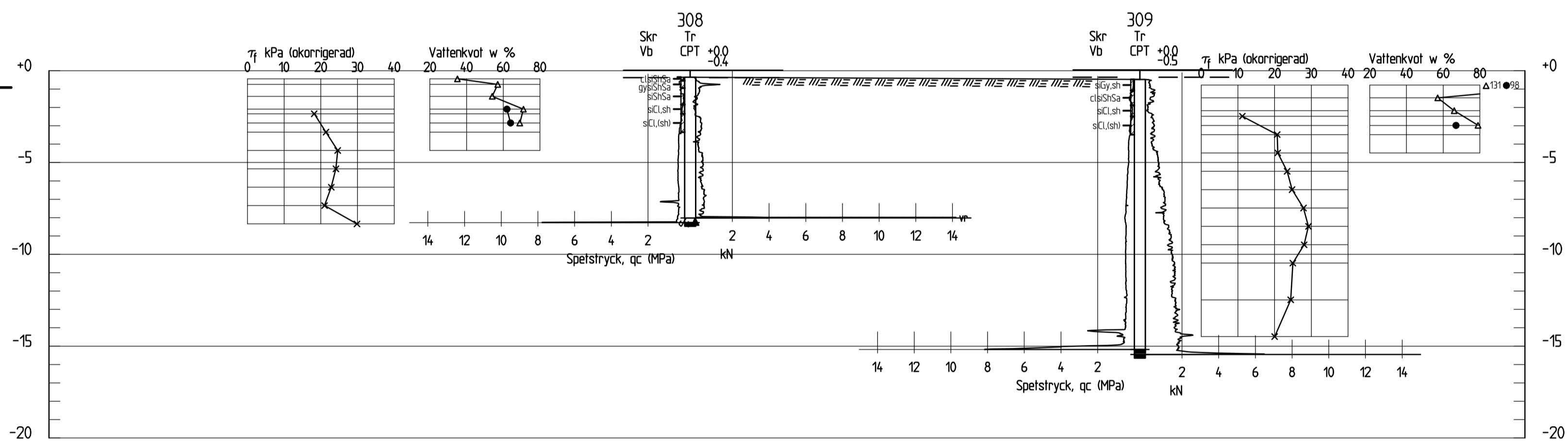

SEKTION C-C  
1: 200

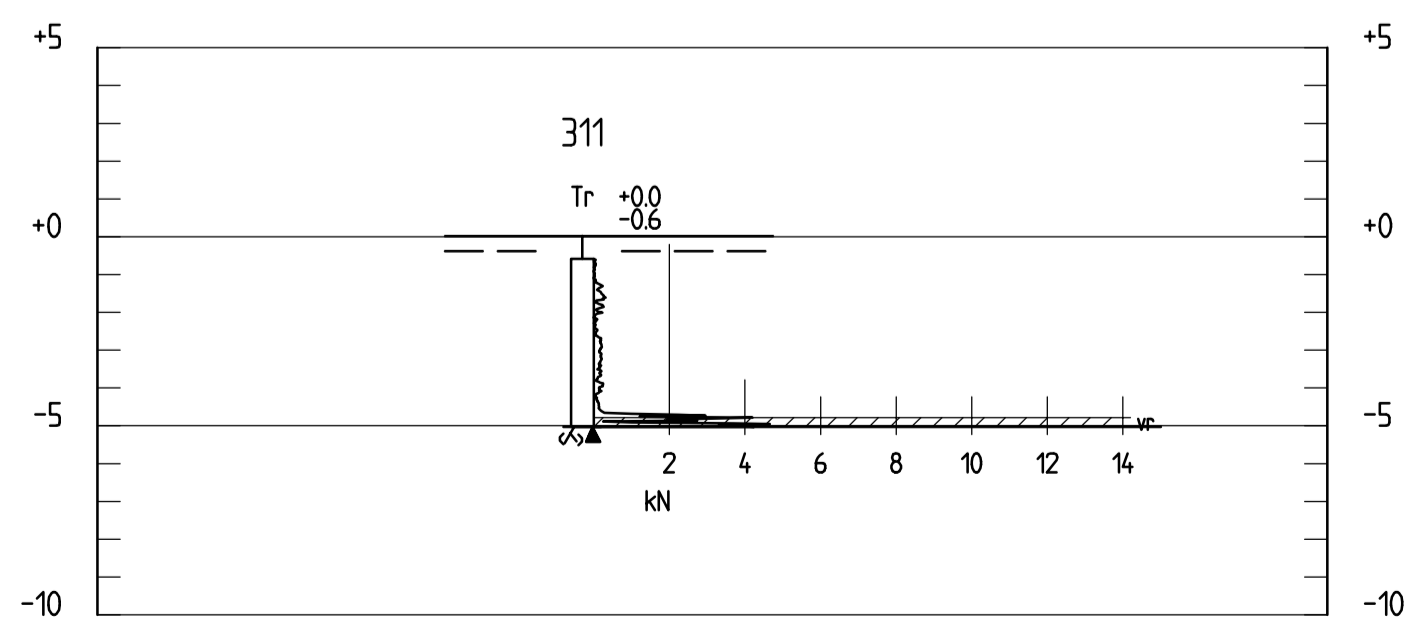



1: 200

SYMBOLER OCH BETECKNINGAR  
SS-EN 14688-1  
SGF BETECKNINGSBLAG, daterad 2016-11-01  
SGF/BGS BETECKNINGSSYSTEM. Se www.sgf.net

HÖJDSYSTEM  
RH 2000

FÖRKLARINGAR  
MARKYTAN MELLAN SONDERINGSPUNKTERNA  
ÄR EJ AVVÄGD.

BET	ANT	ÄNDRINGEN AVSER	SIGN	DATUM
<b>ARÖD</b>				
RÖNNÄNG, TJÖRNS KOMMUN DETALJPLAN				
 <b>TJÖRNS KOMMUN</b> 471 80 SKÄRHAMN 0304-60 10 00				
 <b>bohusgeo</b> Bhusgeo AB Bastiongatan 26, 451 50 UDDEVALLA TEL. 0522-946 50 www.bohusgeo.se				
UPPDRAGSNR 17023	RITAD K DRVAL WARTA			
DATUM 2017-07-10	HANDELAGGARE H LUNDSTRÖM			
GRANSKAD DL	UPPDRAGSANSVARIG HENRIK LUNDSTRÖM			
<b>GEOTEKNISK UNDERSÖKNING</b> SEKTIONER B-B, C-C OCH 311				
SKALA (FÖRHÅT)	(A1)	RITNINGSNR	BET	
1:200		<b>G302</b>		

**SYMBOLER OCH BETECKNINGAR**

SS-EN 14688-1  
SGF BETECKNINGSBLAG, daterad 2016-11-01  
SGF/BGS BETECKNINGSSYSTEM. Se www.sgf.net

**HÖJDSYSTEM**

RH 2000

**FÖRKLARINGAR**

MARKYTAN MELLAN SONDERINGSPUNKTERNA  
ÄR EJ AVVÄGD.

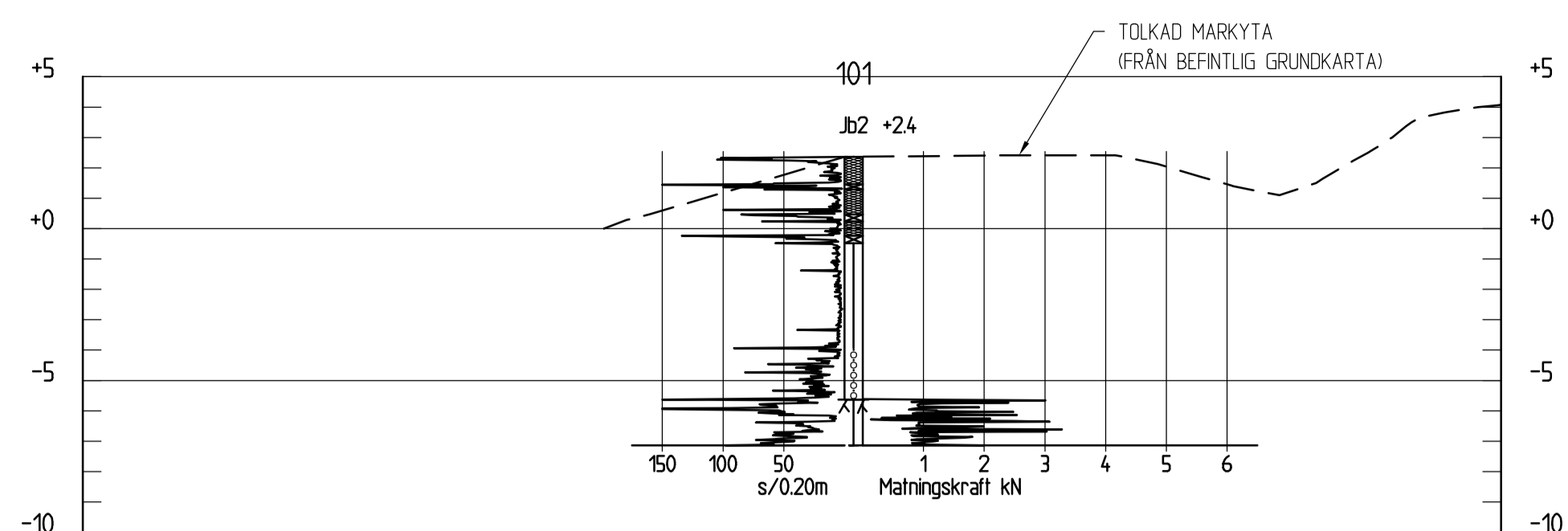

1: 200

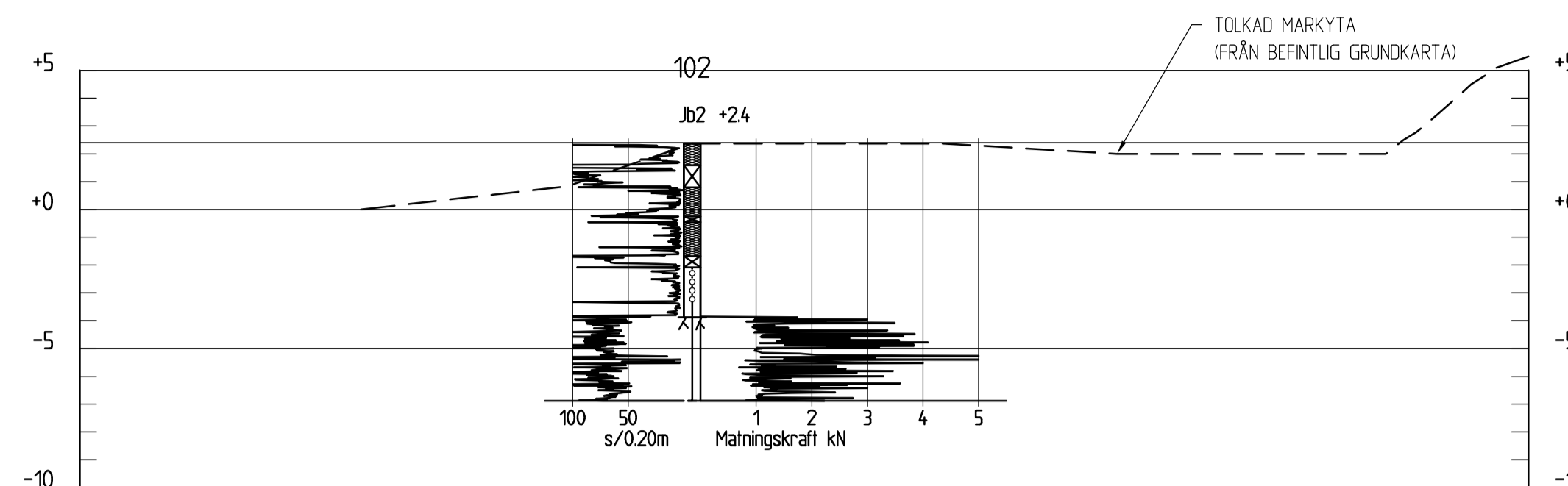

1: 200

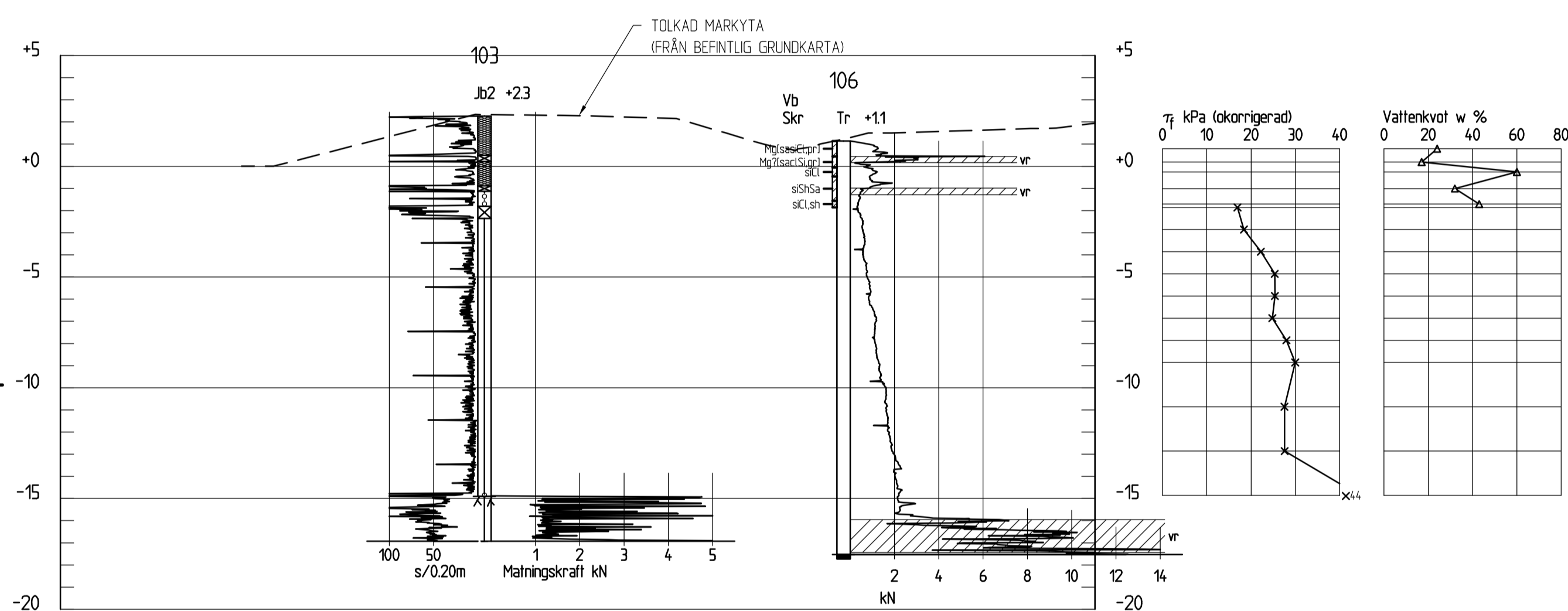

**SEKTION D-D**

1: 200

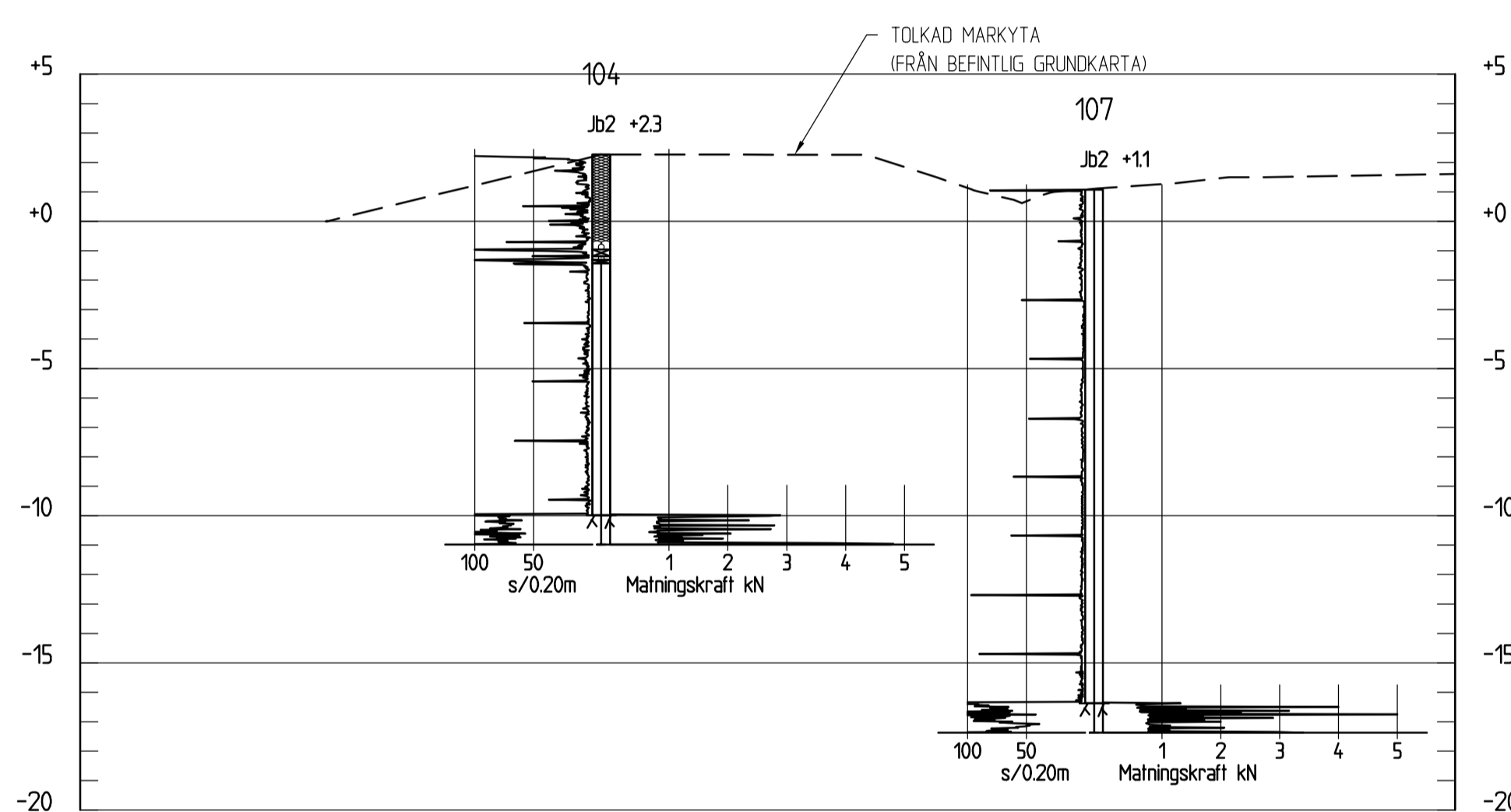

**SEKTION E-E**

1: 200

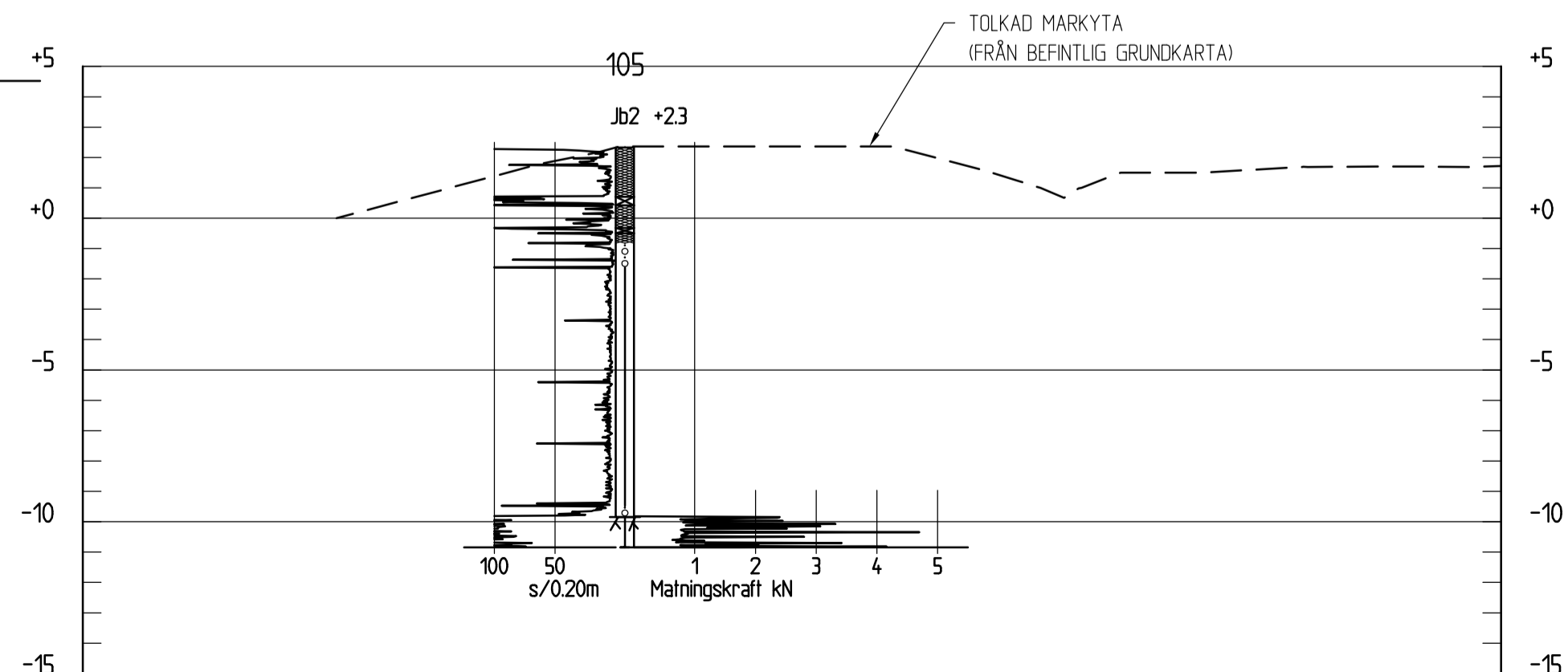

1: 200

BET	ANT	ÄNDRINGEN AVSER	SIGN	DATUM
-----	-----	-----------------	------	-------

**ARÖD**

RÖNNÄNG, TJÖRNS KOMMUN  
DETALJPLAN

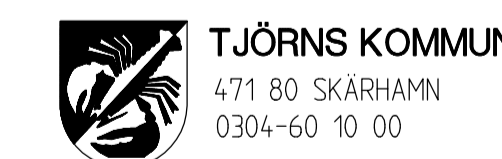

Bohusgeo AB  
Bastionsgatan 26, 451 50 UDDEVALLA TEL. 0522-946 50  
www.bohusgeo.se

UPPROGSRNR 17023	RITAD K DRVAL WARTA
DATUM 2017-07-10	HANDLÄGGARE H LUNDSTRÖM
GRANSKAD DL	UPPROGGSANSVARIG HENRIK LUNDSTRÖM

**GEOTEKNISK UNDERSÖKNING**  
SEKTIONER 101, 102, D-D, E-E OCH 105

SKALA (FORMAT)	(A1)	RITNINGSNR	BET
1:200		G303	

referens: \\sage\sv\Nammrin\_A\1\1\dagj...M\del\1\GM-G\3\1\dagj...M\del\1\U\logga\j\pms\_kommun.dwg\1\G303-A.dwg

FILE: K:\2017\17023\_ARÖD\CAD\RI\DEF\G303.DWG





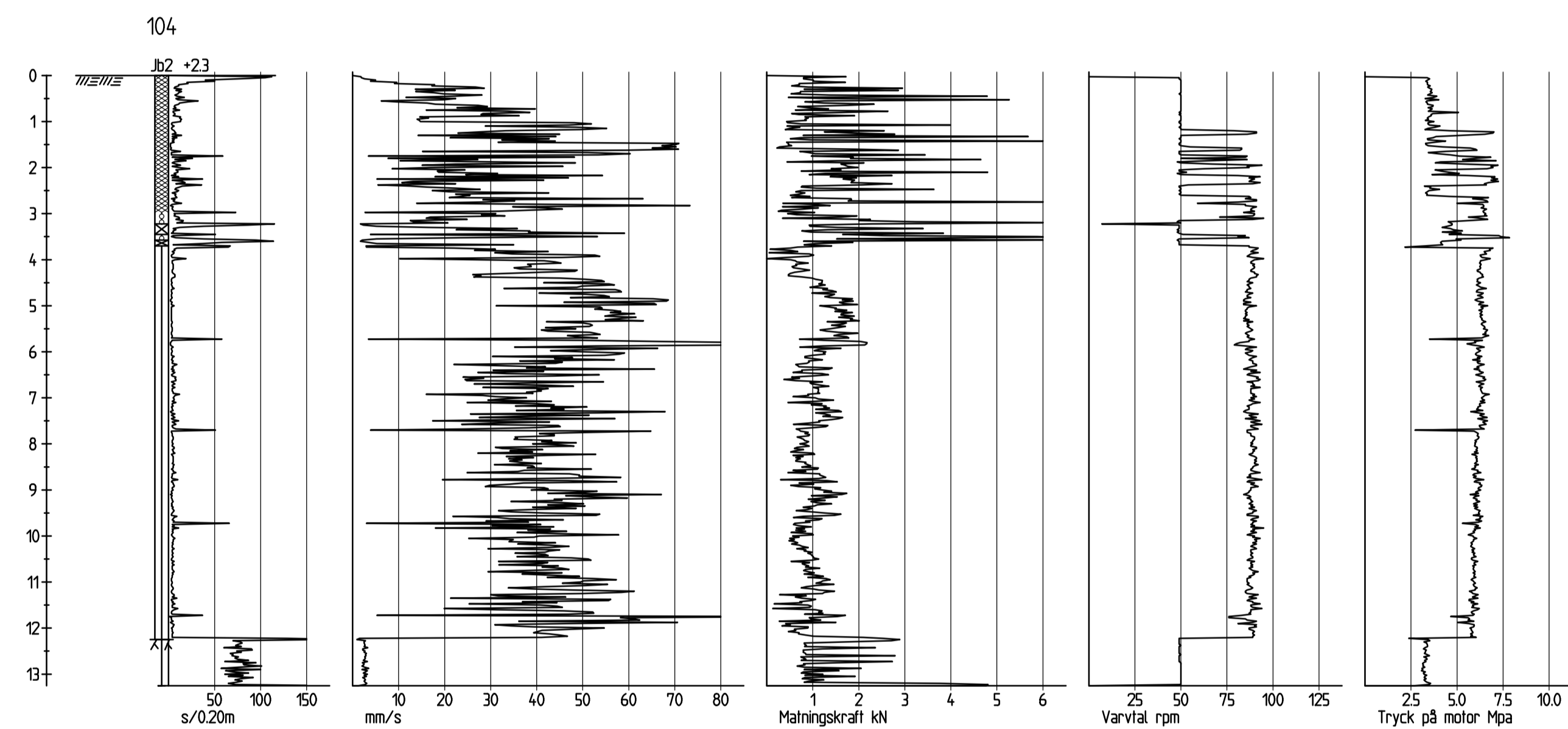
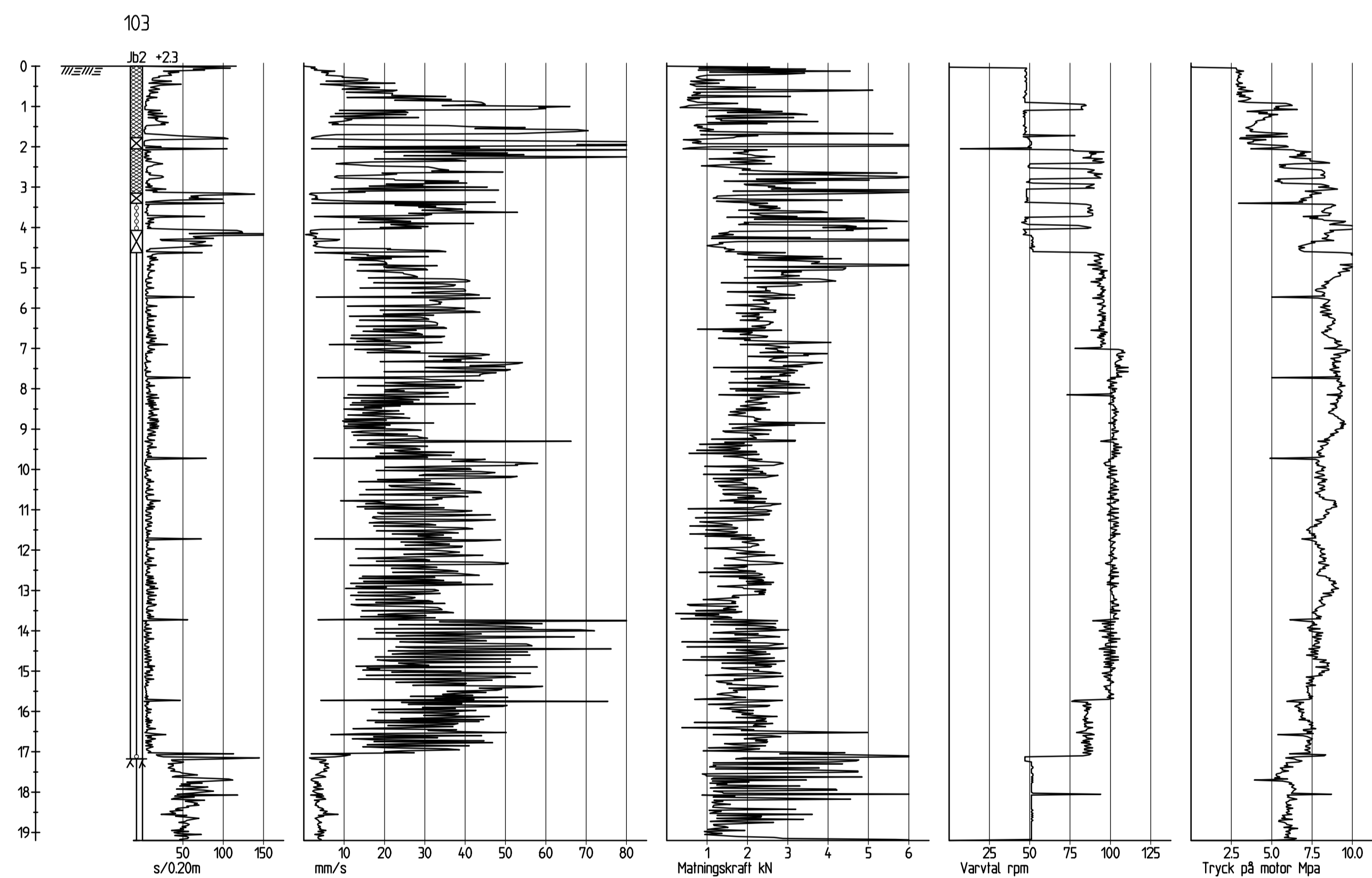
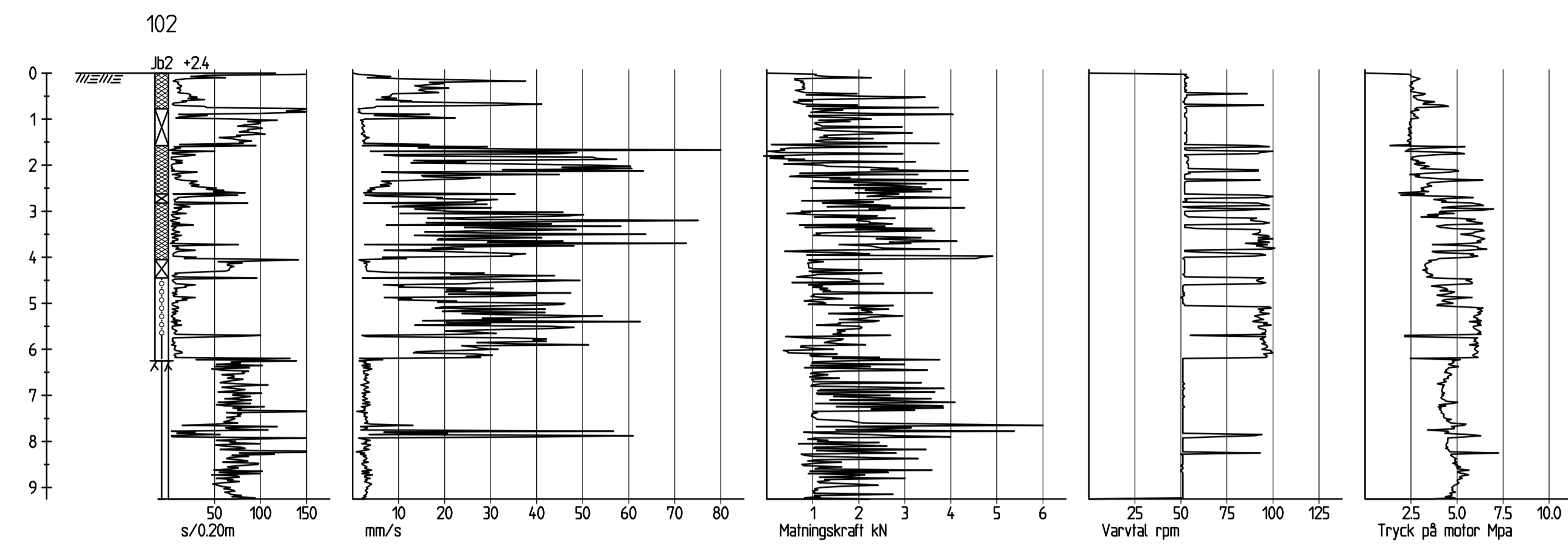
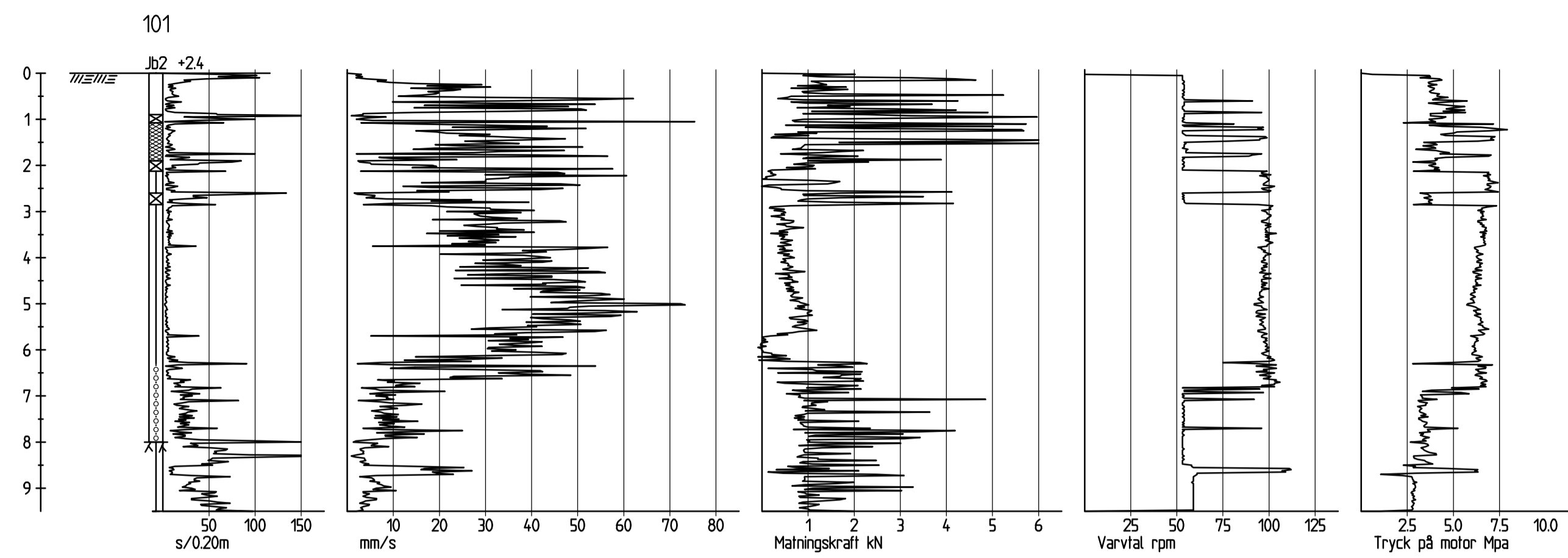

SYMBOLER OCH BETECKNINGAR  
SS-EN 14688-1  
SGF BETECKNINGSBLAG, daterad 2016-11-01  
SGF/BGS BETECKNINGSSYSTEM. Se [www.sgf.net](http://www.sgf.net)

HÖJDSYSTEM  
RH 2000

BET	ANT	ÄNDRINGEN AVSER	SIGN	DATUM

## ARÖD

RÖNNÄNG, TJÖRNS KOMMUN  
DETALJPLAN



471 80 SKÄRHAMN  
0304-60 10 00

**bohusgeo**

Bohusgeo AB  
Bastiongatan 26, 451 50 UDDEVALLA TEL. 0522-946 50  
[www.bohusgeo.se](http://www.bohusgeo.se)

UPPDRAGS NR 17023	RITAD K DRVAL WARTA
DATUM 2017-07-10	HANDLÄGGARE H LUNDSTRÖM
GRANSKAD DL	UPPDRAGSANSVARIG HENRIK LUNDSTRÖM

GEOTEKNISK UNDERSÖKNING  
JORD-BERGSONDERINGAR  
SEKTIONER 101 TILL 104

SKALA (FÖRHÅLL)	(A1)	RITNINGSNR	BET
1:100		G306	

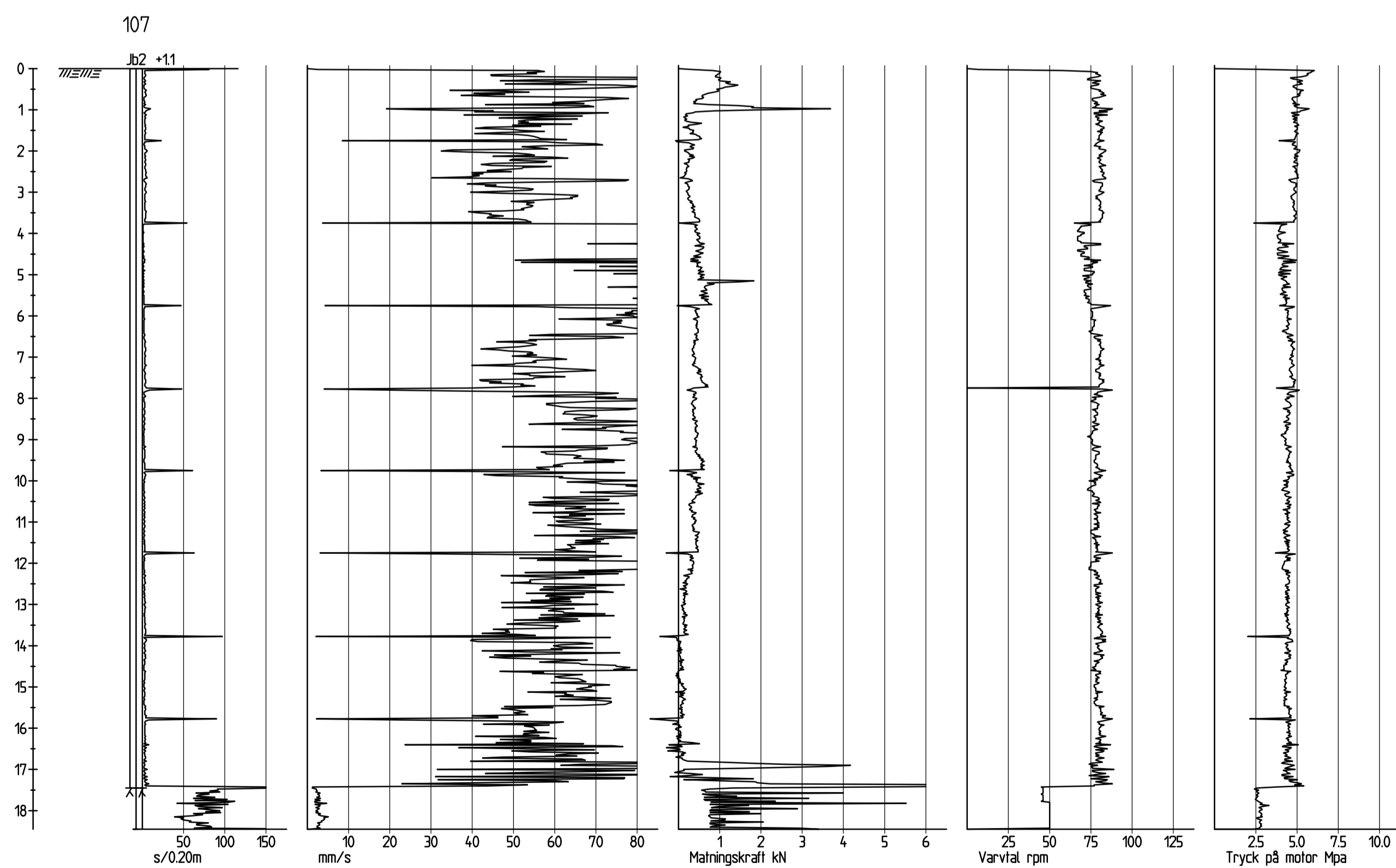
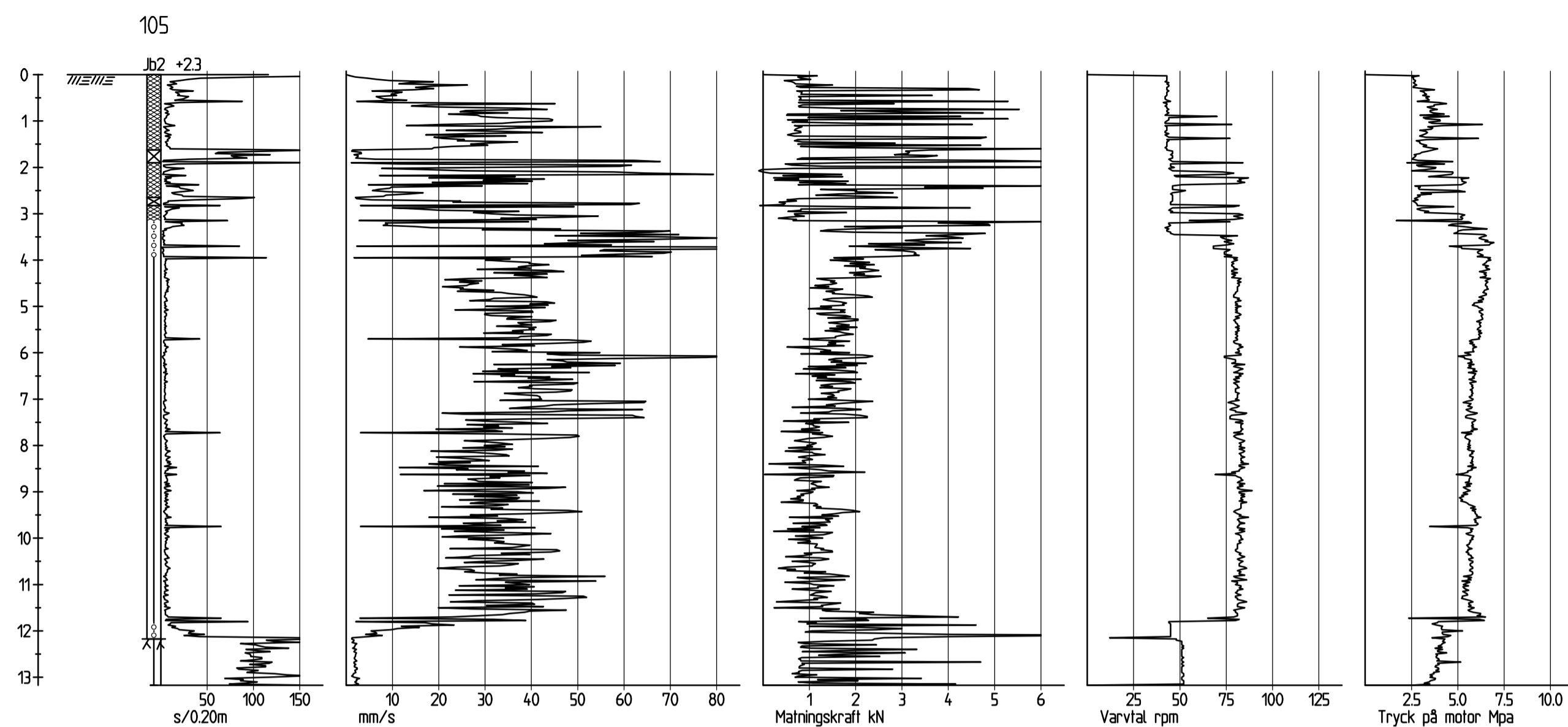

BET	ANT	ÄNDRINGEN AVSER	SIGN	DATUM
-----	-----	-----------------	------	-------

## ARÖD

RÖNNÄNG, TJÖRNS KOMMUN  
 DETALJPLAN



471 80 SKÄRHAMN  
 0304-60 10 00



Bohusgeo AB  
 Bastiongatan 26, 451 50 UDDEVALLA TEL. 0522-944 50  
 www.bohusgeo.se

UPPDRAGSNR 17023	RITAD K DRWAL WARTA
DATUM 2017-07-10	HANDELAGGARE H LUNDSTRÖM
GRANSKAD DL	UPPDRAGSANSVARIG HENRIK LUNDSTRÖM

GEOTEKNISK UNDERSÖKNING  
 JORD-BERGSONDERINGAR  
 SEKTION 105 OCH 107

SKALA (FÖRHÅLL)	(A1)	RITNINGSNR	BET
1:100		G307	